

CALIFORNIA STATE UNIVERSITY, NORTHRIDGE

WiTricity: Wireless Power Transfer

A Graduate Project submitted in fulfillment of the requirements
For the Degree of Master of Science in
Electrical Engineering

By

Pranit Yeole

MAY 2013

The Graduate Project of Pranit Yeole is approved:

Dr. Ali Amini

Date

Dr. Ahmad Bekir

Date

Dr. Ignacio Osorno, Chair

Date

California State University, Northridge

ACKNOWLEDGEMENT

It gives me immense pleasure and satisfaction in presenting the project report on “WiTricity: Wireless Power Transfer” towards the partial fulfillment of Master of Science degree in Electrical Engineering.

I wish to express my sincere gratitude to Dr. Bruno for his kind guidance, valuable suggestions and timely advices. I would also like to thank each and every person who helped me in completion of this project directly or indirectly.

I would like to thank my parents and friends for their constant encouragement and help.

Pranit Yeole

TABLE OF CONTENTS

Signature Page	II
Acknowledgement	III
List of figures	VI
Abstract	VII
1. Introduction	1
2. Theory	3
2.1. Resonance	3
2.2. Resonators	3
2.3. Resonant Energy Transfer	4
2.4. Resonant Coupling	4
2.5. Energy Transfer and Efficiency	5
2.6. Coupled Mode Theory	5
2.6.1. Simulation Results in Different Coupled Modes	7
2.6.1.1. Energy Transfer With $k/T \gg 1$	7
2.6.1.2. Energy Transfer Without $k/T \gg 1$	8
2.6.1.3. Influence of k/T on the Total Energy of the System	9
2.6.2. Dielectric Disks	10
2.6.3. Capacitively-loaded conducting wire loops	11
3. WiTricity	14
3.1. What WiTricity is not?	14
3.1.1. Traditional Magnetic Induction	14
3.1.2. Radioactive Power Transfer	14
3.1.3. MRI	14
3.2. What WiTricity is?	15
3.3. Why WiTricity?	15
3.4. Range	16
3.5. Evanescent Waves	16
3.6. How it works	17
4. Prototype Circuit	18
4.1. Self Oscillating Circuit	18
4.2. High Frequency Resonant Transformer	19
4.3. Output Circuitry	20
5. Efficiency	21
6. Applications	23
6.1. WiTricity in Implantable Devices	23
6.1.1. Structure of Energy Transmission System	24
6.2. Solar Power	24
6.3. Consumer Electronics	25
6.4. Industrial	25

6.5. Other Applications	26
6.6. WiTricity technology will make products	26
7. Conclusion	27
8. References	28

LIST OF FIGURES

Fig.1: Energy variation in each resonant coil and total energy at $k/T = 250$	7
Fig.2: Energy variation at $k/T=15$	8
Fig.3: Energy variation at $k/T=5$	8
Fig.4: Energy variation at $k/T=1$	8
Fig.5: Energy variation at $k/T=0.5$	9
Fig.6: Variation in Total energy of the system with the growth of k/T	9
Fig.7: A 2D high- ϵ disk of radius r surrounded by air	10
Fig.8: System of two same 2D high- ϵ of radius r	11
Fig.9: A wire loop of radius r connected to a pair of d -spaced parallel plates	11
Fig.10: System of two wire loops connected to parallel plates	12
Fig.11: Single source coil powering multiple devices	15
Fig.12: Distance/Radius vs. k/Γ	16
Fig.13: WiTricity circuit used to glow LED bulb	17
Fig.14: Prototype Circuit	18
Fig.15: Self Oscillating Circuit	18
Fig.16: High Frequency Resonant Transformer	19
Fig.17: Output Circuitry	20
Fig.18: Efficiency of a WiTricity model using dielectric disks and wire loops	21
Fig.19: Comparison of experimental and theoretical efficiencies as functions of the wireless power distance	22
Fig.20: The scheme of energy transmission system for implantable device	24
Fig.21: Comparison of existing and wireless solar panel systems	25

ABSTRACT

WiTricity: Wireless Power Transfer

By

Pranit Yeole

Master of Science in Electrical Engineering

The concept of WiTricity is based on the well known mechanism of strongly coupled magnetic resonance. This emerging technology is used “to transmit power efficiently over a mid-range distance” which is “a few times the size of the resonator”. In WiTricity, energy exchange takes place between two objects with the same resonant frequency, whereas the interaction with extraneous off-resonant objects is weak. This emerging technology will lead to no more messy wires and with widespread enough use it could even eliminate costly batteries. Every year millions of tons of plastic and copper go into device wiring worldwide. WiTricity could help minimize total environmental impact of these devices.[1][3]

WiTricity has many applications in automobile, oil, biomedical and every other industry that uses electronic devices that run on power. One of the applications of WiTricity is in the biomedical industry that produces millions of instruments or appliances that alleviate pain, restore health and extend life which contribute to human welfare. Utilizing WiTricity within implantable device like cardiac pacemakers could lessen the size of the implanted battery and could provide an alternative for battery replacement surgeries.

The purpose of this project is to explore WiTricity and understand the theory behind it. I will also be looking at the benefits of WiTricity and its use in development of applications. The Project work concerns with the simulation of WiTricity model in MatLab Simulink and development of a prototype WiTricity model.

1. Introduction

Nikola Tesla at the turn of the 20th century developed a system for transferring large amounts of power across continental distances. Tesla's aim was to bypass the electrical-wire grid. The project was never completed due to a number of technical and financial difficulties this.

In the past decade there has been tremendous rise in the use of electronic devices, such as laptops, cell phones, PDA's, robots- all of which run on batteries. Medical implants are also playing major role in today's industry. Such devices include implantable cardiac pacemakers, insulation pumps, cardiac defibrillators, drug infusion pumps, deep brain stimulators. As these devices need to perform properly, they store lot of energy making their non rechargeable batteries heavy and large. Also rechargeable batteries need to be constantly recharged for their continuous use.

To overcome these problems Scientists at MIT came up with an idea in which a physical phenomenon would enable a source and a device to exchange energy efficiently over mid-range distances, while "dissipating relatively little energy in extraneous objects". This phenomenon is called as "WiTricity". WiTricity signifies wireless energy transfer. Using WiTricity electrical energy can be supplied to remote objects without using wires. In this concept, electromagnetic energy is transmitted from a power source (transmitter) to an electrical load (receiver), without interconnecting wires.[11]

Mid-range means that the separation between the two objects affecting the transfer should be of the order of a few times the characteristic sizes of the objects. This implies that one source could be used to power or recharge all portable devices within an average sized room. In future it can be used to charge phones or laptops signing into a power zone. This technology can be established in similar way as Wi-Fi technology is capturing the market now. WiTricity is of a great use in various fields like electric vehicles and wireless sensors, where critical environmental conditions make it troublesome to run wiring. Without wires power transmission is often a more suitable, greener alternative to conventional plug-in charging.

The charging devices that are in use, such as the cord for a cell phone works on the principle of electromagnetic induction. An electric current is transferred from a power conductor, which generates a magnetic field, to a smaller magnetic field generated by a receiving device. A transformer is a good example of electromagnetic induction. An electric current is induced in the secondary winding by an electric current running in the primary winding. In these cases, the distance between the two coils has to be very short and the two coils may even overlap, but they never make electrical contact with each other. However, if the distance between the coils becomes larger than their characteristic sizes, the efficiency of the power transfer reduces by orders of magnitude. A few other examples of devices that work on electromagnetic induction are rechargeable electric toothbrushes and inductive charging pads. The WiTricity devices work on the similar phenomenon, however magnetic fields are generated "through a process called resonant magnetic coupling" and this "allows power to be transmitted several meters in distance".[12][13]

The basic concept is that there may be a general strongly coupled regime of operation in systems of coupled resonances (e.g. acoustic, electro-magnetic, magnetic, nuclear). By the general physical property, the energy transfer is supposed to be very

efficient, if the given system is operated in this regime. Substantive of the geometry of the surrounding space, mid-range power transfer implemented this way can be nearly omnidirectional and efficient and will have low losses into most off-resonant environmental objects.[7]

The above considerations hold true independent of the physical nature of the resonances. The focus is on one particular physical embodiment: magnetic resonances, meaning that the interaction between the objects occurs predominantly through the magnetic fields they generate. The system based on the principle of magnetic resonances would be safer, more efficient, and suitable for daily use, as biological tissue and “most common materials interact weakly with magnetic fields”. At first glance, such power transfer is reminiscent of the usual magnetic induction; however, note that the usual non-resonant induction is very inefficient unless the two coils share a core with high magnetic permeability or are very close to each other. Moreover, operating on resonance is necessary but not sufficient to achieve good efficiency at mid-range distances. Indeed, Tesla's pioneering work made extensive use of resonant induction, and many technologies available today (e.g., radio receivers, RFID tags, and cochlear implants) also rely on resonance, yet their efficiencies are not very good at mid-range distances. For the efficient power transfer, working in the strong-coupling regime is necessary, for which resonance is a precondition.[1]

The Soljagic and his MIT team built the WiTricity system with energy emitters and receivers. The newness of this system was that the electromagnetic evanescent waves of these emitters and receivers radiated great distances without significant decay. Also, these evanescent fields were tuned to resonate with each other. As the evanescent fields of the emitter and receiver could see each other, this enhanced the transfer. But they could not see the extraneous objects having different resonances, even if those objects were in the line-of-sight between emitter and receiver. Furthermore, these waves do not dissipate energy to the environment; hence this technology is substantially more efficient than beaming energy via conventional electromagnetic radiation.[7]

According to Soljagic's *Science Express* paper, the energy transfer efficiency of REC is about 40% over a 2-meter distance, and the MIT researchers estimate that REC can transfer 1,000,000 times more energy wirelessly than conventional electromagnetic waves. More importantly, transferring identical quantities of energy over the same distance using a copper wire of ample diameter would incur negligible losses. Nonetheless, while it can't compete with wired energy transfer, WiTricity represents a quantum leap in wireless energy transmission.[7]

2. Theory

2.1. Resonance:

As per physics theory, the tendency of any system, generally a linear system, to oscillate at higher amplitude at specific frequencies compared to other is called as resonance. These particular frequencies are called as resonance frequencies and large amplitude oscillations can be produced at these frequencies even by small periodic driving forces.

The capability of a system to store and transfer energy between two or more storage modes gives rise to resonance. In case of a pendulum, it's kinetic and potential energy attribute to resonance. Every physical system has a natural frequency at which it oscillates at maximum amplitude. When the system is set to oscillations, the losses in each cycle called damping results in decrease of the amplitude. The resonant frequency of the system is approximately equal to its natural frequency when the damping is minimal.

Consider a circuit consisting of inductors and capacitors. When the magnetic field of the inductor collapses, electric current is induced in the winding which leads to charging of the capacitor. Now, when the capacitor discharges the resulting electric current creates a magnetic field in the inductor and this process repeats continuously. Resonance can occur if the inductive reactance and the capacitive reactance of the circuit happen to be equal in magnitude and this results in oscillation of electrical energy between the electric and magnetic fields of capacitor and inductor respectively.

Under resonance, the inductor and capacitor have minimum series impedance and maximum parallel impedance whereas, the inductive and capacitive reactance are equal in magnitude. Hence we get,

$$\begin{aligned}\omega L &= 1/\omega C \\ \therefore \omega &= \frac{1}{\sqrt{LC}}\end{aligned}$$

Where ω is the resonant frequency of the circuit.

2.2. Resonators:

Every physical system has its own degree of freedom. Based on its degree of freedom the physical system has many resonance frequencies equal to the number of degree of freedom, with which it vibrates as a harmonic oscillator. Systems like mass on a spring, LC tuned circuits, simple pendulums, etc; have a single degree of freedom and a corresponding resonant frequency. Coupled pendulums and resonant transformers are some of those systems that have two resonant frequencies. The time taken for energy to transfer from one oscillator to another depends significantly on the number of coupled harmonic oscillators. The vibrations undergo wave propagation through the coupled harmonic oscillators. Objects like organ pipes, vibrating strings, quartz crystals, etc; are called resonators which undergo resonance due to the internal vibrations. These

resonators are made of many moving parts which are coupled together and can have various resonance frequencies. The waves caused by the vibrations in the resonator are repeatedly bounced back and forth between the sides of the resonator at a constant velocity. Considering the distance between the sides of the resonator as d , the wave travels a distance $2d$ in a single roundtrip. When the initial phase of the wave is equal to the phase of the sinusoidal wave after one complete cycle, the waves reinforce causing resonance. Thus, the resultant condition for resonance is that the distance travelled by the wave in a roundtrip is equal to the numerical integer wavelength λ of the wave; i.e.

$$2d = N\lambda, \quad N \in \{1,2,3,\dots\}$$

Considering the wave velocity as v and the frequency as $f = v/\lambda$, the resonance frequencies can be determined as:

$$f = \frac{Nv}{2d} \quad N \in \{1,2,3,\dots\}$$

Thus, the resonance frequencies of the resonators are the multiples of the lowest frequency known as the fundamental frequency at equal spacing. These multiples are called as overtones. Depending on various modes of vibrations, a system can have multiple series of resonance frequencies.

2.3. Resonant Energy Transfer:

Short range wireless energy transmission technologies such as WiTricity, which use magnetic fields for the transmission, function on the principle of resonant energy transfer. It has been proved that magnetic fields are less likely to cause health issues in human beings as compared to electric fields.

For wireless transmission of energy using these kinds of systems require two coils which have the same resonant frequency. Another requirement, to have less losses and better efficiency, is that the coils should have high quality factor Q . Energy transmission takes place when these coils resonate at the resonant frequency. Sometimes such a system may be called a resonant transformer which uses air core to avoid iron losses. The two coils can be housed in the same equipment or separate enclosures may be used.

When an oscillating current is passed through a coil ring with high resonant frequency, it creates a strong oscillating magnetic field. Based on the phenomenon of resonant coupling, if any other coil with same resonant frequency is placed in the vicinity of this coil, energy gets transferred.

2.4. Resonant Coupling:

The power can be transferred without wires using non resonant coupling as used in transformers. In this case the primary coil generates a magnetic field and the secondary coil tries to grasp as much energy as possible. For this operation, it is very necessary to have magnetic core in between the two coils. This method is highly inefficient when the distance between the two coils is large and results in wastage of energy due to resistive losses in the primary coil. By using resonance the efficiency can be helped dramatically.

In this case, a tuned LC circuit is formed by loading each coil to its full capacity. A significant amount of power can be transmitted over a considerable distance between the two coils that are resonant at a common frequency.

2.5. Energy Transfer and Efficiency:

As per the principle, when a primary coil loaded in full capacity is subjected to a significant amount of energy, the coil rings along with the formation of an oscillating magnetic field. There is an energy transfer between the inductor's magnetic field and capacitor's electric field, at resonant frequency. Decaying of the oscillations due to resistive and radiative losses, is based on the Q factor of the coil. Most of the energy can still be transferred if the secondary coil manages to cut through the field and absorbs energy before it is lost in each cycle.

The primary coil forms a series RLC circuit, and the Q factor for such a coil is:

$$Q = \frac{1}{R} \sqrt{\frac{L}{C}}$$

The Q factor of the two coils plays a vital role in the wireless energy transmission. By maintaining a high Q factor, one can achieve higher efficiency between two coils kept several diameters apart, even though the field generated by the coil weakens as the field travels further away from the point of origin.

2.6. Coupled Mode Theory:

The resonant energy exchange is based on a well-known: coupled mode theory. According to this theory, the field of the system of two resonant coils 1 and 2 is approximated by [3],

$$F(r, t) \approx a_1(t)F_1(r) + a_2(t)F_2(r)$$

Where $F_{1,2}(r)$ are the eigen modes of resonant coils 1 and 2 alone, and $a_{1,2}(t)$ are the field amplitudes of two coils. Then the energy exchange between the two resonant coils can be expressed using the following differential equations [3]

$$\begin{cases} \frac{da_1(t)}{dt} = (i\omega_1 - \Gamma_1)a_1(t) + ik_{11}a_1(t) + ik_{12}a_2(t) \\ \frac{da_2(t)}{dt} = (i\omega_2 - \Gamma_2)a_2(t) + ik_{22}a_2(t) + ik_{21}a_1(t) \end{cases} \quad (1)$$

Where $\omega_{1,2} = 2\pi f_{1,2}$ are the individual resonant angular frequencies, $\Gamma_{1,2}$ are the individual resonance decay rates due to the intrinsic losses of coils via radiation into free space and absorption inside the material, k_{11} and k_{22} are the coupling coefficients between the resonant coils and non-resonant objects, k_{12} and k_{21} are the coupling coefficients between the resonant coils 1 and 2.[3]

The coupling coefficients between the resonant coils and non-resonant objects are much smaller than those between the resonant coils 1 and 2, ($k_{11}, k_{22}, \ll k_{12}, k_{21}$). Equation (1) can be simplified as [3]

$$\begin{cases} \frac{da_1(t)}{dt} = (i\omega_1 - \Gamma_1)a_1(t) + ik_{12}a_2(t) \\ \frac{da_2(t)}{dt} = (i\omega_2 - \Gamma_2)a_2(t) + ik_{21}a_1(t) \end{cases} \quad (2)$$

Taking the Laplace transform on (2), we have,

$$\begin{cases} sL(a_1(t)) - a_1(0) = (i\omega_1 - \Gamma_1)L(a_1(t)) + ik_{12}L(a_2(t)) \\ sL(a_2(t)) - a_2(0) = (i\omega_2 - \Gamma_2)L(a_2(t)) + ik_{21}L(a_1(t)) \end{cases} \quad (3)$$

Solving (3), we have

$$\begin{cases} L(a_1(t)) = \frac{ik_{12}a_2(0) + a_1(0)(s + \Gamma_2 - i\omega_2)}{(s + \Gamma_1 - i\omega_1)(s + \Gamma_2 - i\omega_2) + k_{12}k_{21}} \\ L(a_2(t)) = \frac{ik_{21}a_1(0) + a_2(0)(s + \Gamma_1 - i\omega_1)}{(s + \Gamma_1 - i\omega_1)(s + \Gamma_2 - i\omega_2) + k_{12}k_{21}} \end{cases} \quad (4)$$

Assuming that the resonant coils 1 and 2 are both ideal, having the identical parameters and the resonant coil 1 initially contains the entire energy of the system [3]

$$\begin{cases} \omega = \omega_1 = \omega_2 \\ \Gamma = \Gamma_1 = \Gamma_2 \\ k = k_{12} = k_{21} \\ a_1(0) = 1 \\ a_2(0) = 0 \end{cases} \quad (5)$$

Under these conditions, (4) can be further simplified as [3]

$$\begin{cases} L(a_1(t)) = \frac{s + \Gamma - i\omega}{(s + \Gamma - i\omega)^2 + k^2} \\ L(a_2(t)) = \frac{ik}{(s + \Gamma - i\omega)^2 + k^2} \end{cases} \quad (6)$$

Taking inverse Laplace transforms on (6), we have

$$\begin{cases} a_1(t) = e^{(i\omega - \Gamma)t} \cos(kt) \\ a_2(t) = e^{(i\omega - \Gamma)t} \sin(kt) \end{cases} \quad (7)$$

Then the total energy transferred in the system can be calculated by, [3]

$$p(t) = p_1(t) + p_2(t) = |a_1(t)|^2 + |a_2(t)|^2 = e^{-2\Gamma t} \quad (8)$$

where $p(t)$ is the total energy of system, $p_1(t)$, $p_2(t)$ are the energy in coils 1 and 2 respectively.

2.6.1. Simulation Results in Different Coupled Modes:

Eqs. (7) and (8) above indicate that the decreasing rate of the total energy transferred in the system is directly affected by resonant decay rate, and the coupling coefficient reflects the transmission rate of energy between the two resonant coils. Therefore, k/T is the distance dependent figure-of-merit for the resonant energy transfer system.[3]

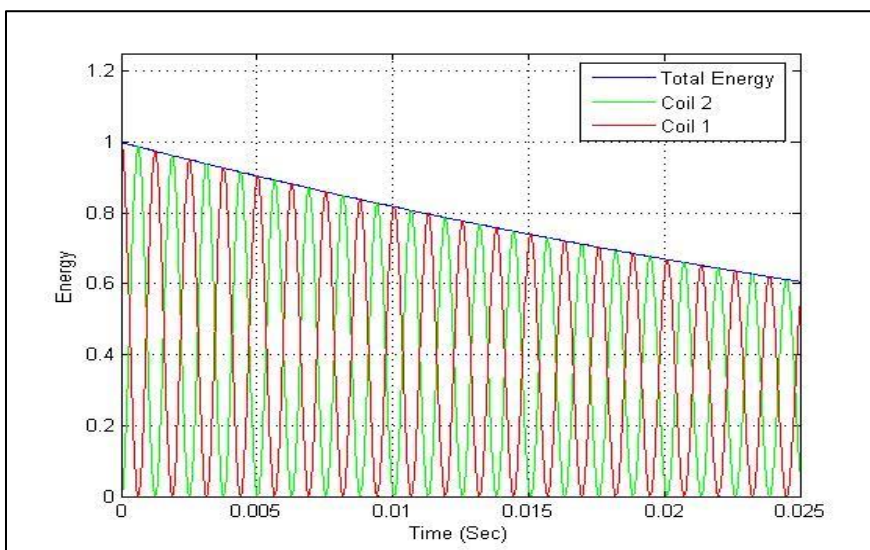

Fig.1: Energy variation in each resonant coil and total energy at $k/T = 250$ [3]

2.6.1.1. Energy Transfer With $k/T \gg 1$:

The optimal strongly coupled mode of the energy transmission system is under the condition of $k/T \gg 1$, that is, the energy transferred to the destination should be much more than that lost during the transmission process. To illustrate, we plot three curves representing the energy variation in each resonant coil and the total energy of the system at $k/T=250$ as shown in Fig.1. We can see that the energies in coils 1 and 2 are continually exchanged via a strong energy transmission channel, meanwhile, the total energy in system has a slight decrease with time prolonged. Stimulating program of the equations in the Matlab we got the nature of total energy of the resonating coil system at $k/T= 15$ and $k/T=5$ as shown in fig 2 and Fig. 3 respectively.[3]

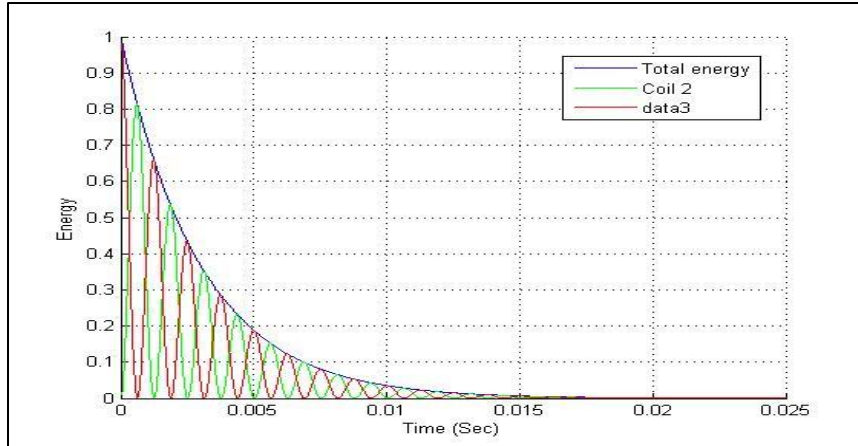

Fig.2: Energy variation at $k/T=15$ [3]

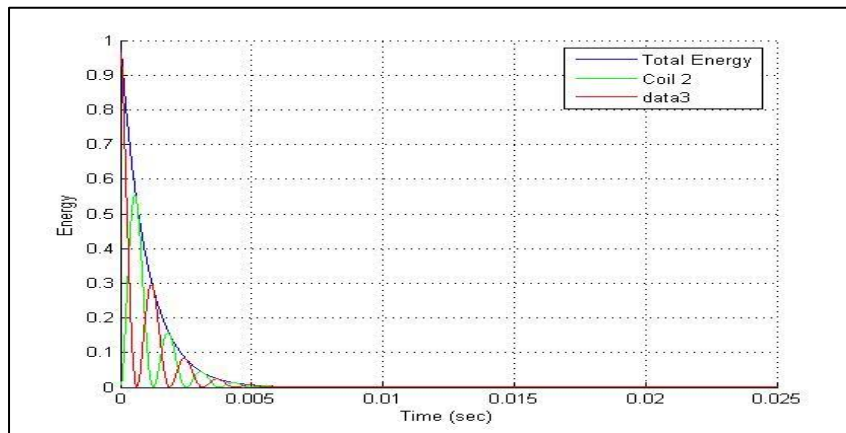

Fig.3: Energy variation at $k/T=5$ [3]

2.6.1.2. Energy Transfer Without $k/T \gg 1$:

The energy will be lost before an efficient resonant energy transmission channel is formed if $k/T \gg 1$ is not satisfied. As can be seen in Fig.4 and Fig.5, the energy in the system decreases rapidly when $k/T=0.5$ and $k/T=1$. Though the transmission improves as k/T increases.[3]

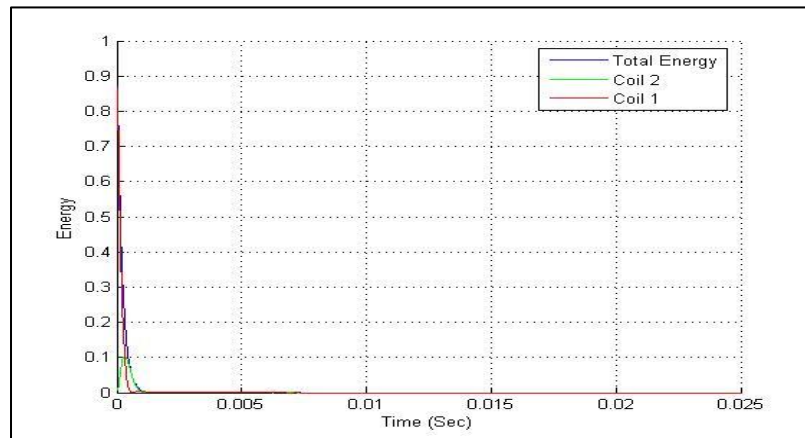

Fig.4: Energy variation at $k/T=1$ [3]

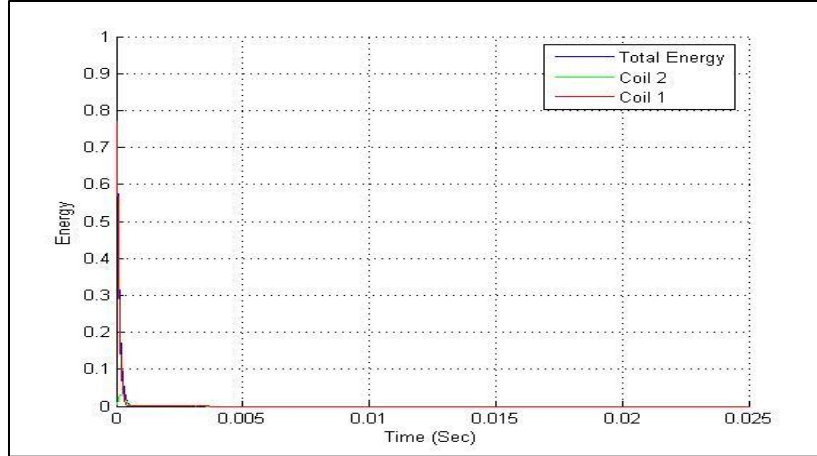

Fig.5: Energy variation at $k/T=0.5$ [3]

2.6.1.3. Influence of k/T on the Total Energy in System:

Based on the above analysis, we can see that k/T is a significant parameter in the energy transmission system. With the growth of k/T , the proportion of energy lost in system decreases and the total energy decays more slowly. Shown in Fig. 6, the total energy in system is proportional to the time and varying nearly linearly when $k/T > 50$. [3]

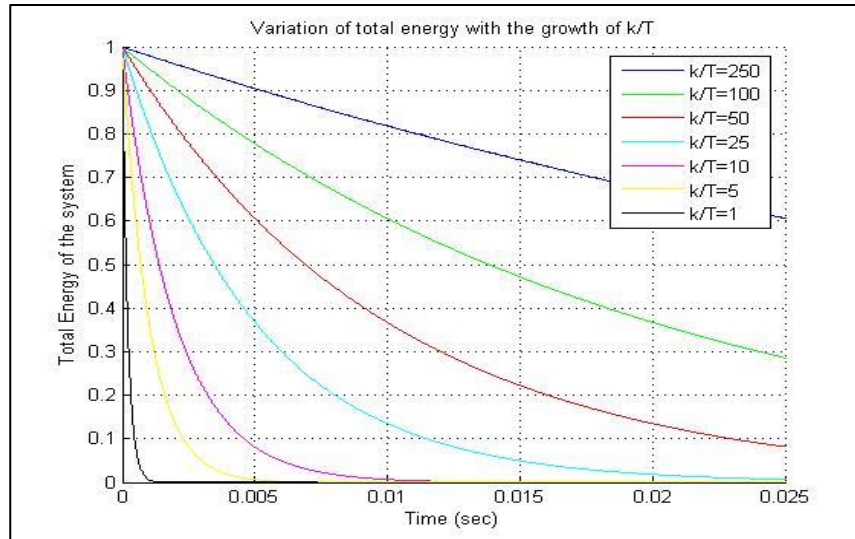

Fig.6: Variation in Total energy of the system with the growth of k/T [3]

Subsequently, the energy-transfer application requires resonant modes of high $Q = \omega/2\Gamma$ for low (slow) intrinsic-loss rates, and this is why a scheme where the coupling is implemented using, not the lossy radiative far-field, but the evanescent (non-lossy) stationary near-field has been proposed. Furthermore, strong (fast) coupling rate k is required over distances larger than the characteristic sizes of the objects, and therefore, since the extent of the near-field into the air surrounding a finite-sized resonant object is

set typically by the wavelength (and quantified rigorously by the “radiation caustic”), this mid-range non-radiative coupling can only be achieved using resonant objects of sub-wave length size, and thus significantly longer evanescent field-tails. This is a regime of operation that has not been studied extensively, since one usually prefers short tails to minimize interference with nearby devices. The sub-wave length resonances can often be accompanied with a high radiation-Q, so this will typically be the appropriate choice for the possibly-mobile resonant device-object d . Note, though, that the resonant source-object s will in practice often be immobile and with less stringent restrictions on its allowed geometry and size, which can be therefore chosen large enough that the near-field extent is not limited by the wavelength.[6]

Based on the coupled mode theory MIT performed two experiments to transfer power wirelessly. Two experiments that MIT performed are discussed below.

2.6.2. Dielectric Disks:

MIT used “a 2D dielectric disk object of radius r and relative permittivity ϵ surrounded by air that supports high- Q “whispering gallery” resonant modes. The energy stored inside such a system” is lost by “radiation into free space and absorption inside the disk material”. When the azimuthal field variations are slow and the dielectric permittivity ϵ is large, high- Q^{rad} and “long-tailed subwavelength resonances can be achieved”. Material absorption depends on the material loss tangent [6]:

$$Q^{abs} \sim Re\{\epsilon\}/Im\{\epsilon\}$$

MIT team performed simulations numerically and analytically, and these simulations implied that for a properly designed resonant low-loss-dielectric object the following values should be achievable.

$$Q^{rad} \geq 2000 \text{ \& } Q^{abs} \sim 10000$$

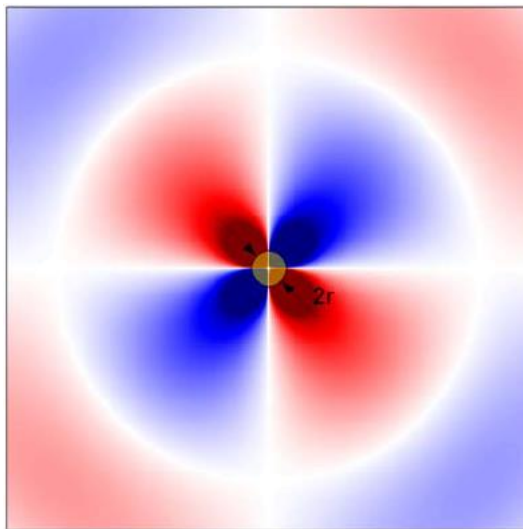

Fig.7: A 2D high- ϵ disk of radius r surrounded by air [6]

Now, “to calculate the achievable rate of energy transfer between two disks 1 & 2”, they are placed at a distance D between their centers. After performing numerical and analytical simulations for medium distances [6]:

$$D/r = 10 - 3$$

and for non-radiative coupling such that,

$$D < 2r_c$$

Where, r_c is the radius of the radius caustic, it was found that coupling-to-loss ratios are in the range:

$$k/\Gamma \sim 1 - 50$$

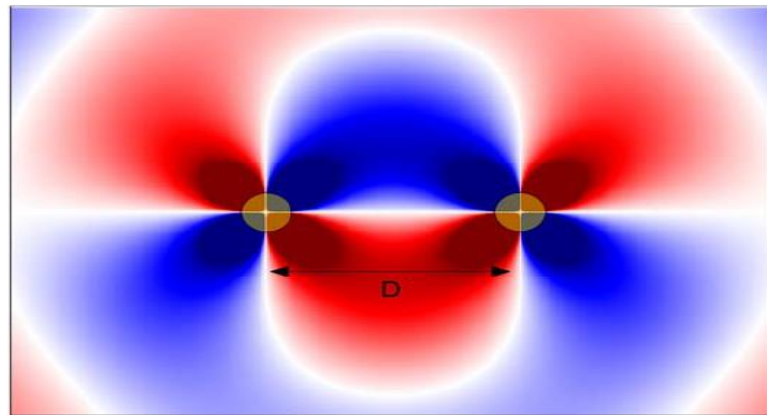

Fig.8: System of two same 2D high- ϵ of radius r [6]

2.6.3. Capacitively-loaded conducting wire loops:

The following diagram shows the idea of capacitively loaded conducting wire loops.

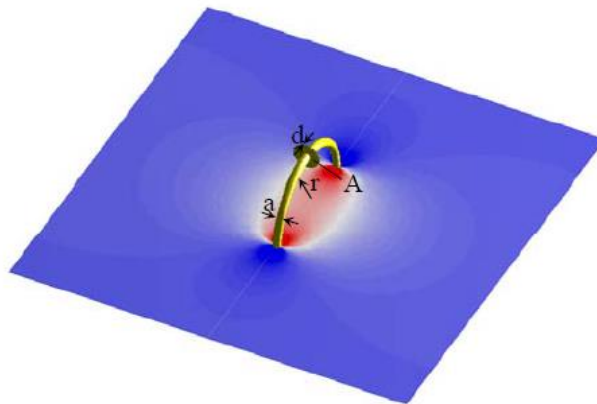

Fig.9: A wire loop of radius r connected to a pair of d -spaced parallel plates [6]

Consider a loop of radius r of conducting wire with circular cross-section of radius a connected to a pair of conducting parallel plates of area A spaced by distance d

via a dielectric of relative permittivity ϵ and everything surrounded by air as shown in above figure. “The wire has inductance L , the plates have capacitance C and then the system has a resonant mode, where the nature of the resonance lies in the periodic exchange of energy from the electric field inside the capacitor, due to the voltage across it, to the magnetic field in free space, due to the current in the wire. Losses in this resonant system consist of ohmic loss R_{abs} inside the wire and radiative loss R_{rad} into free space”. The quality factors can be calculated by [6]:

$$Q^{abs} = \omega L / R_{abs}$$

&

$$Q^{rad} = \omega L / R_{rad}$$

where, ω is the resonant frequency. By tuning the capacitance and thus the resonant frequency, the total Q becomes highest for some optimal frequency determined by the loop parameters: at low frequencies it is dominated by ohmic loss and at high frequencies by radiation. By performing mode solving calculations numerically and analytically, it was found that expected quality factors in the microwave are [6]:

$$Q^{abs} \geq 1000 \text{ \& } Q^{rad} \geq 10000$$

Now, to calculate the achievable rate of energy transfer between two loops 1 & 2, they are placed at a distance D between their centers. After performing numerical and analytical simulations for medium distances:

$$D/r = 10 - 3$$

It was found that coupling-to-loss ratios are in the range:

$$k/\Gamma \sim 0.5 - 50$$

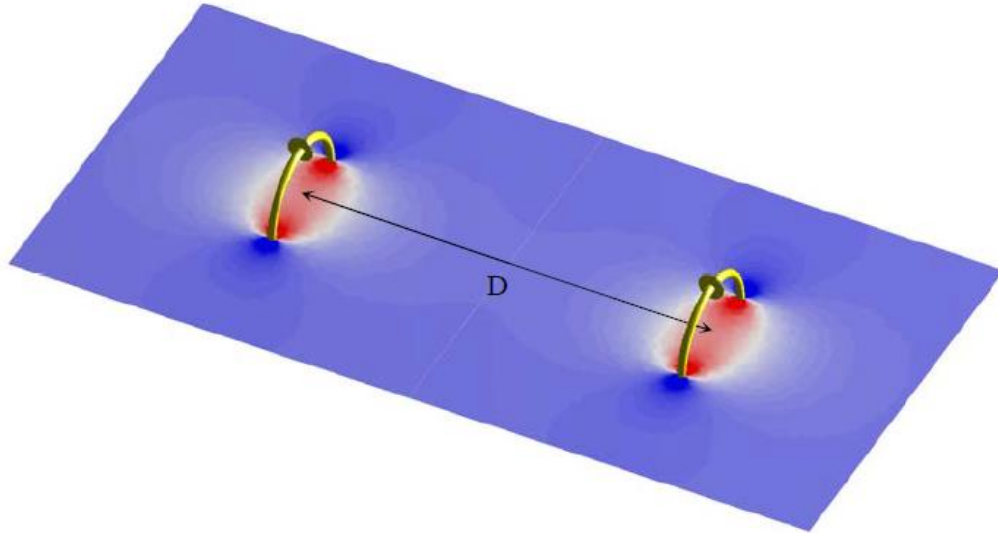

Fig.10: System of two wire loops connected to parallel plates [6]

From the simulations it is proved that wire loops are better at larger distances than the dielectric disk. Also, the influence of extraneous objects at resonances that do not resonate at the same frequency of the capacitively loaded conductive wire loops is almost

none. This is because the field surrounding the wire loops is mainly magnetic due to the electric field between the capacitors. The only objects that could interfere with the wire loops are materials that have magnetic properties. Most importantly, when humans come into the field of the wire loops they are left unaffected. One of the things that the team from MIT was suggesting was that since most sources could be left alone the loop could be bigger that we could pair a big source loop with a small device loop to have better efficiencies at further distances. Doing this would avoid the problems of having a device loop of 1 meter, which would not be realistic for many applications.

3. WiTricity

3.1. What WiTricity is not?

3.1.1. Traditional Magnetic Induction:

Though WiTricity looks like traditional magnetic induction, it is not the same. In the traditional magnetic induction system, conductive coils transmit power to each other wirelessly over very short distances. In this system two coils must be very close to each other and may even overlap. “The efficiency of power transfer drops by orders of magnitude when distance between the coils becomes larger than their sizes”. Examples of traditional magnetic induction power exchange are electronic toothbrushes, charging pads, etc.[14]

3.1.2. Radioactive Power Transfer:

To facilitate transfer of information over a wide spectrum to multiple users, radio frequency energy is broadcasted through radiation. Each radio or wireless receiver unit needs to have an amplifier section with external power supply so as to receive the information. Radio transmission is capable of low power information transfer, but ineffective in case of power transfer as most of the power is lost in free space due to radiation. Other alternatives of power transfer such as feeding more power into the transmitters or using directed radiations using antennas cause high risk of interference with other radio frequency devices and also pose a safety hazard for living organisms which come in between the line-of-sight of the transmitter and the receiver. These limitations make radio transmission an impractical means of wireless power transfer for consumer, commercial, or any industrial application.

The other means of wireless power transfer include visible and invisible light waves such as sun rays, laser beams, etc. The sun being an excellent source of light energy, extensive research is being carried out to capture this energy and convert it to electrical energy using photovoltaic cells. A collimated beam of laser rays can be used to transfer energy in a targeted way. But it requires a clear line-of-sight between the transmitter and the receiver to insure safe and efficient transmission.

3.1.3. MRI:

MRI stands for Magnetic Resonance Imaging used to develop diagnostic images of soft tissues in the human body. It cannot be compared with WiTricity, i.e., Resonant Magnetic Coupling as they both have contrasting principles. The procedure of MRI makes use of a strong DC magnet which orients the magnetic fields of atoms present in the human tissues and also affects the radio frequency fields so as to manipulate those atoms in a desired way to obtain clear images of the tissue structure.

3.2. What WiTricity is?

The term WiTricity is a blend of the words ‘wireless’ and ‘electricity’. It is a form of non radiative power transfer. Most of the other techniques discussed above use radiative forms of power transfer. WiTricity is different as it uses magnetic coupling. In this a clear line of sight between the emitter and receiver is not needed. WiTricity is also a safe mode of power transfer as the interaction between the magnetic fields and biological organisms is not hazardous.

These attributes make WiTricity a form of potential technology which can be used to transfer electricity/power between electrical sources and receivers without the use of wires or cables. Keeping certain factors in mind and also ensuring that the electromagnetic field is strong enough to allow reasonable power transfer, it is possible to transfer power over a certain amount of distance. “This is possible if both the emitter and the receiver achieve magnetic resonance”. Wireless transmission of energy is very helpful in areas where uninterrupted and instantaneous power is required and using wires inconvenient, hazardous, or impossible.[15]

3.3. Why WiTricity?

Imagine a world in which you do not require the use of any kinds of cords to power or charge your electronic devices. Everything from your lamp to your cell phone and even your television set can be charged or powered without cords. This can be made possible with the use of WiTricity. Centuries ago, scientists would have laughed at the idea of wireless communication, but today we cannot imagine a world without cell phones and the internet. The rapid growth and development in the research of wireless technology has helped the world think out of the box. Now it is time for the world to think even further and explore the world of electronics which can be powered wirelessly through the technology provided by WiTricity. By using a single source coil, multiple devices with receiving coil can be powered. With widespread use it could even eliminate costly batteries and there will be no more messy wires.

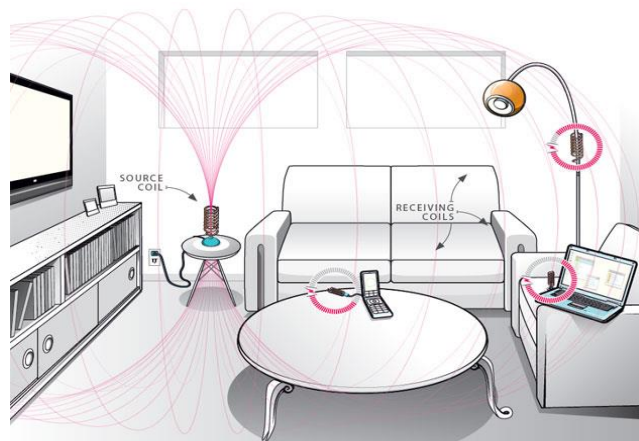

Fig.11: Single source coil powering multiple devices

3.4. Range:

WiTricity technology is designed for “mid-range” distances, which we consider to be anywhere from a centimeter to several meters. The actual operating range for a given application is determined by many factors, including power source and capture device sizes, desired efficiency, and the amount of power to be transferred.[16]

As shown below, the ratio of the distance between the two objects and their radius increases, the ratio of coupling coefficient and resonance widths decreases.

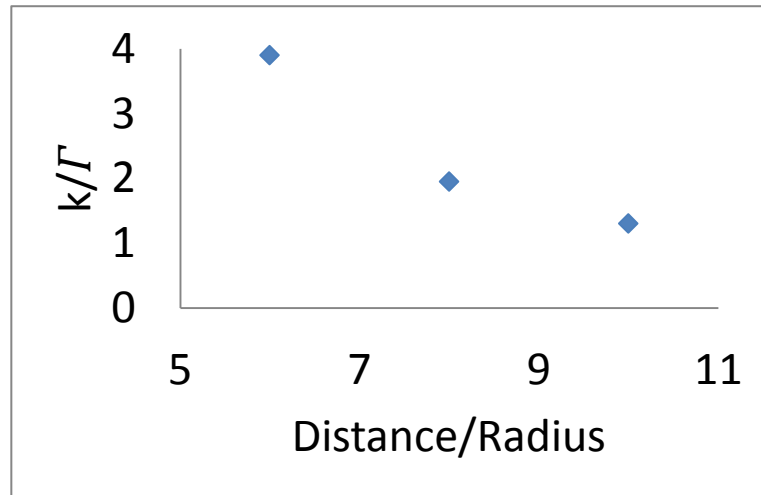

Fig.12: Distance/Radius vs. k/Γ

Here the ratio of coupling coefficient and resonance width represents efficiency. Using different materials will allow us to have less loss at a better distance/radius ratio, because as per equations permittivity of medium is also an important factor.

3.5. Evanescent Waves:

A near field standing wave whose intensity decays exponentially as it travels a distance from the point of its origin is called as an evanescent wave. These waves obey the property of general wave equations. They are originated at the boundary between two media having different wave motion properties and their intensity is maximum within one-third of a wavelength from the surface of occurrence. Evanescent waves are observed in areas of electromagnetic radiation, quantum mechanics, acoustics and string waves.

In the field of optics and acoustics, when the waves traveling in a medium strike the boundary at an angle greater than the critical angle, they undergo total internal reflection which gives rise to evanescent waves. Physically, since the electric and magnetic fields are continuous at a boundary of the medium, the evanescent waves are generated. Similarly, in the case of quantum mechanics, the particle motion which is represented by the Schrödinger wave-function is normal to the boundary and is continuous.

3.6. How it works:

The most simple and common example of acoustic resonance is shattering of a wine glass by an opera singer. When identical wine glasses are filled with different quantity of wine, they each have different resonance frequencies. Now, when an opera singer sings and a certain voice pitch matches the resonant frequency of a specific glass, the acoustic energy accumulated by the glass is sufficient for it to explode, while other glasses remain unaffected. Thus, there exists a strongly coupled regime in all systems of coupled resonators and highly efficient energy transfer is achieved when operated in this regime.

Since WiTricity operates in a non-radiative field, there is an advantage that even if the receiving coil does not pick up all the power, the residual power remains in the vicinity of the sending coil and is not lost in the environment due to radiation.

The WiTricity circuit is designed in a way that the frequency of the alternating current is increased to the resonant frequency. The travelling current induces magnetic and electric fields in the inductor and capacitor loops respectively which extends up to 5 meters around the device. This magnetic field induces an electric current in the inductor loop of any mobile gadget having the receiver coil with the same resonant frequency. Thus both the circuits resonate together and energy transfer is achieved.

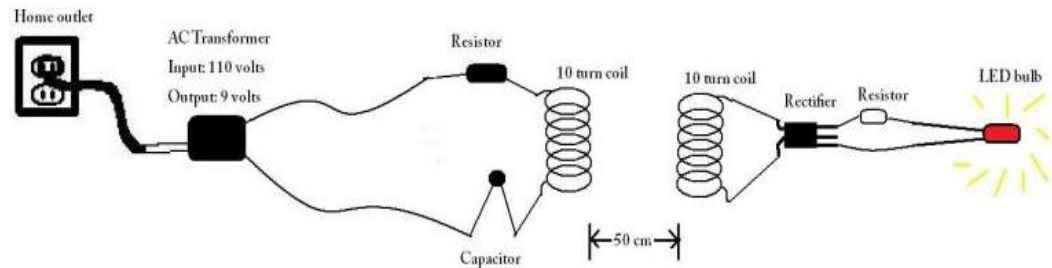

Fig.13: WiTricity circuit used to glow LED bulb.

The above circuit is a good example of the WiTricity system. As can be seen from the diagram, it uses two coils which are tuned at the same resonant frequency. The main supply is given to transformer which induces high frequency AC on the primary coil. When secondary coil comes in the vicinity of the primary coil, power gets transferred from primary to secondary. Power transfer takes place as high frequency gets induced on the secondary coil. The signal at the secondary coil is rectified and given to the load.

Something the MIT team realized is that if evanescent tails (tails of energy) are made larger than the size of the objects, energy could be conserved and energy lost due to radiation will be less. This is something that they did differently from many previous tests, because most of the time, long evanescent tails lead to higher interference between the devices.

4. Prototype Circuit

The prototype circuit is mainly divided into three parts as:

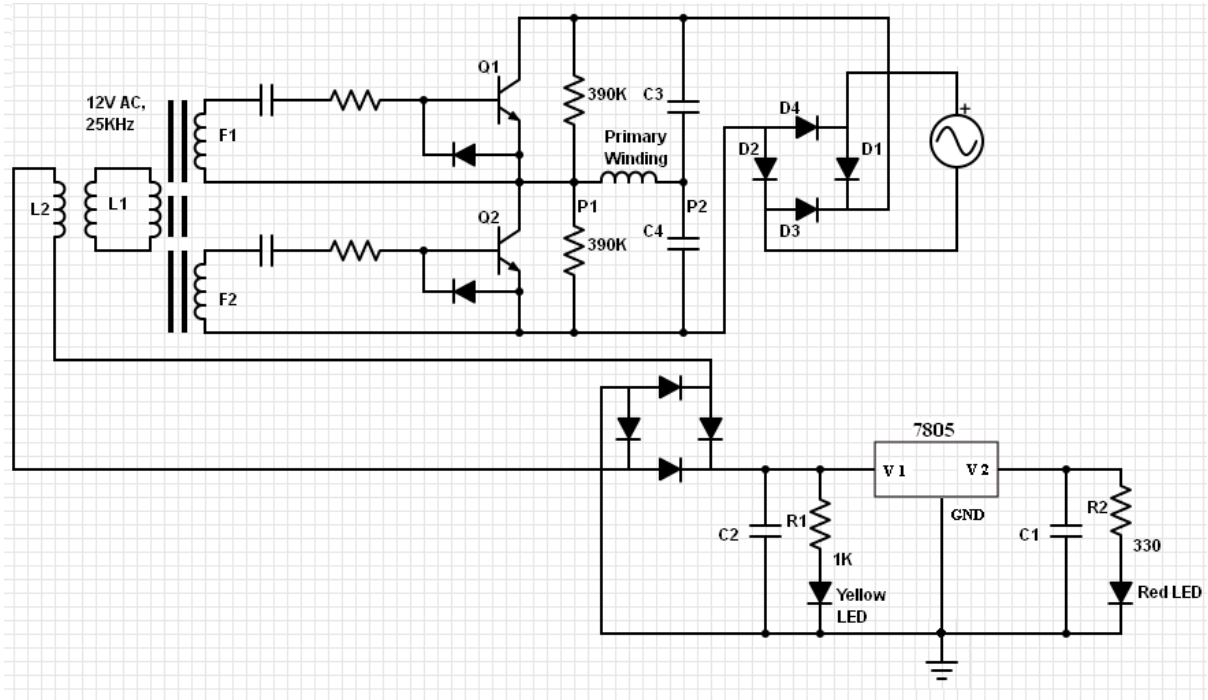

Fig.14: Prototy Circuit

4.1. Self Oscillating Circuit

4.2. High Frequency Resonant Transformer

4.3. Output Circuitry

4.1. Self Oscillating Circuit:

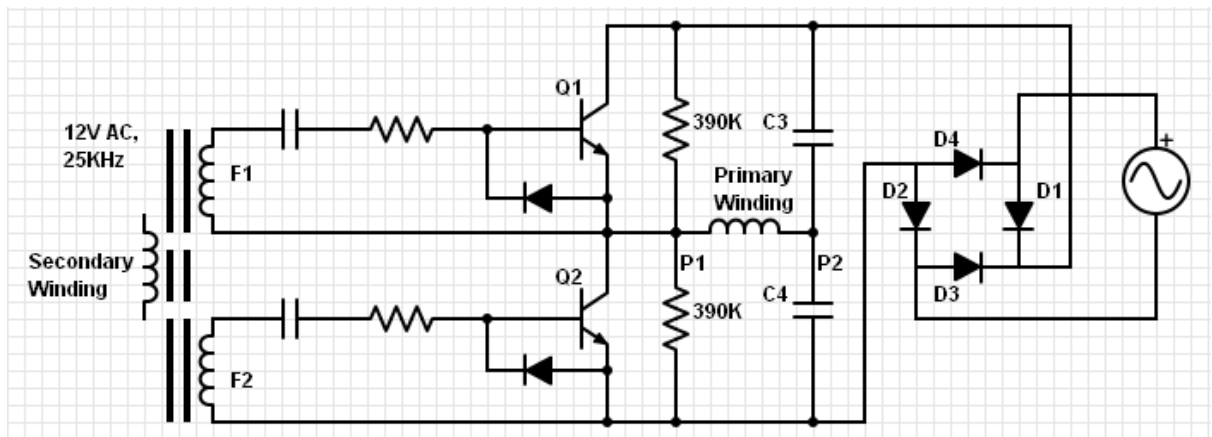

Fig.15: Self Oscillating Circuit

The self oscillating circuit mainly consists of bridge rectifier, transformer with auxiliary winding, NPN BJT 13003, high frequency resonant transformer, filter capacitors. The input part of the circuit consists of two half wave rectifiers and 13003 bipolar junction transistors (BJTs). The input circuit generates a pair of opposite polarity AC signals, positive at F1 and negative at F2, as current flowing through the primary winding induces magnetic field in the secondary winding and a pair of opposite AC signal gets generated in auxiliary windings of the saturable transformer. Two BJTs are connected in circuit in such a way that base of each BJT gets triggered by one polarity AC wave received from respectively induced auxiliary winding. Hence, when one BJT is forward biased other gets reverse biased during each half cycle. The BJT used APT13003D is a high voltage, high speed, high efficiency switching transistor and it is specially designed for off-line switch mode power supplies with low output power. The circuit scheme of half-bridge rectifiers under inductive loads features the function of zero-voltage-switching and clamped-voltage (ZVS-CV) helping to reduce the reverse-recovery problem of freewheeling diode and the turn-off loss of transistors by two transition capacitors. So the two transition capacitors act as in parallel when both transistors are off.[17][18]

AC supply of 110V 60Hz is provided to the primary windings through full wave bridge rectifier. Bridge rectifier doubles the frequency of supply. When input is positive, current flows through diode D1 and triggers Bipolar Junction Transistor Q1 from collector to emitter base junction as winding F1 is forward biased. The current passing through primary winding P1 P2 and diode D2 of bridge rectifier completes the circuit. Capacitors C3 and C4 act as a filter and ripples of the circuit gets blocked.

In the similar manner for negative input, diode D3 and D4 of bridge rectifier get forward biased and current passes through biased F2 winding, switching BJT Q2 and thus completes the circuit.

The capacitors are used to retain the charge filtering purpose and the remaining ripples in the circuit are blocked. Primary winding of high frequency resonant transformer is connected to secondary coil of the saturable transformer. Let's study the resonant transformer in detail.

4.2. High Frequency Resonance Transformer:

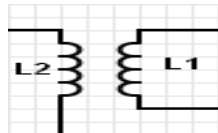

Fig.16: High Frequency Resonant Transformer

The two coils of a transformer resonate at same frequency by the electro dynamic induction or magnetic coupling of electrical energy by the equipment called a resonance

transformer. While many transformers consist of two coils existing in single equipment or can comprise of two different equipments employ resonance, this type has a high quality factor Q by avoiding 'iron' losses.

Resonant transfer works by generating oscillating current with coil ring in an oscillating magnetic field. Highly resonant coil sustains energy placed in coil for longer duration. As we have studied previously, if two coils are near, maximum energy can be transferred before it is lost. Keeping all hardware well within the 1/4 wavelength distance, radiates little energy from the transmitter to receiver. The fields used are predominately non-radiative evanescent waves.

Because of the high coupling coefficient, even though when low power is given as input to the transmitter coil, a relatively intense field builds up by resonance of the frequency, increasing the power received by receiver coil and comparatively far more percentage of power is fed into the coil.[20]

4.3. Output Circuitry:

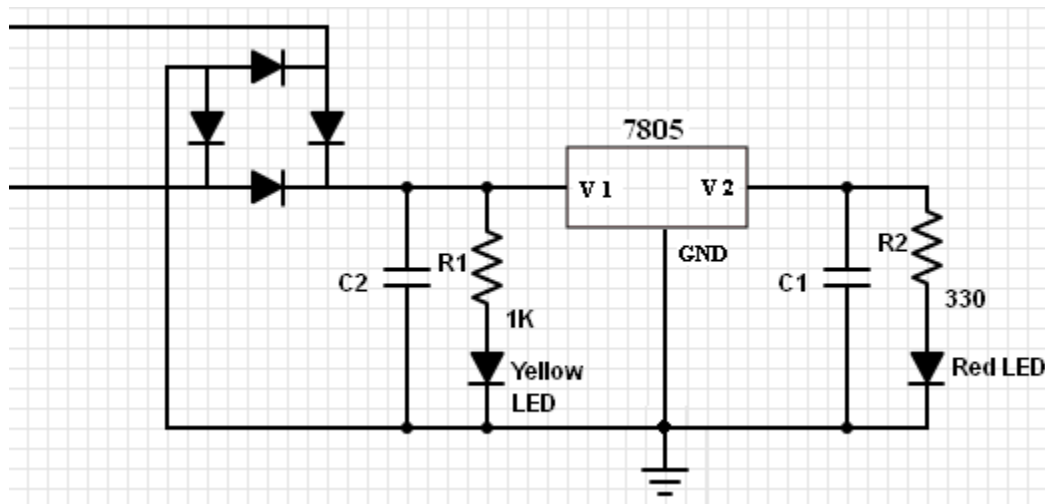

Fig.17: Output Circuitry

The receiver resonant coils are designed with similar specifications to the primary transmitting coils. Low impedance of both windings absorbs optimal energy. To use energy transmitted to the secondary coil, different methods can be used: the AC can be used directly or rectified and a regulator circuit can be used to generate DC voltage.

In this prototype circuit, AC signal at the output of secondary coil is converted to DC for our application. The bridge rectifier connected to transformer secondary coil in addition with capacitor acting as a filter gives one polarity signal pulsed DC voltage output. Regulator IC7805 regulates voltage to 5V and we get output voltage 5V as well as 12V as per the requirement. To monitor the output LEDs are used in the circuit.

5. Efficiency

The efficiency plot for two example systems of dielectric disks and conducting loops is as shown below.

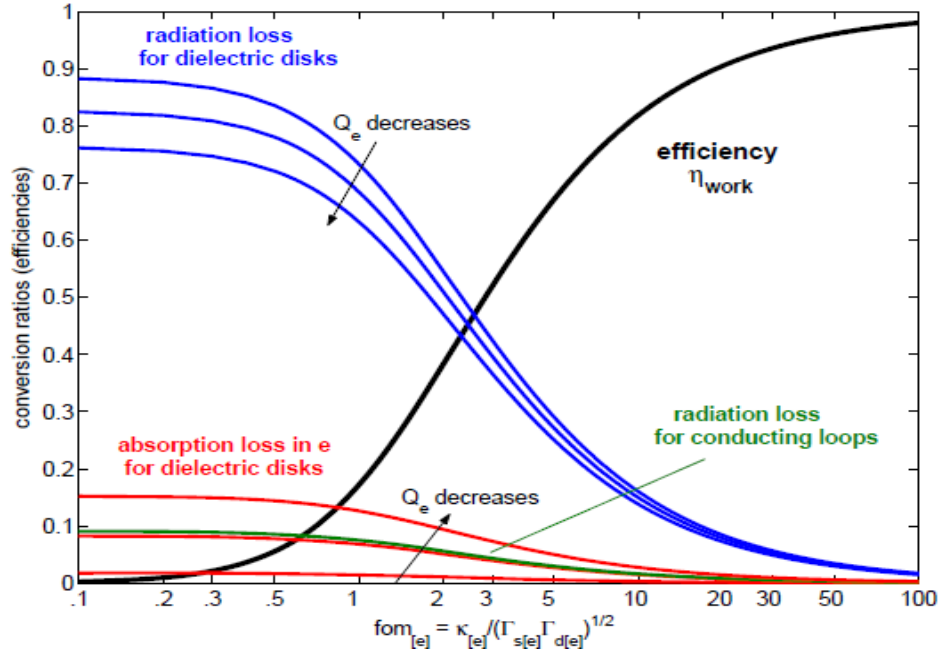

Fig.18: Efficiency of a WiTricity model using dielectric disks and wire loops [6]

We see that the overall efficiency increases as the ratio of the coupling coefficient to resonance width increases. We also see that the radiation loss for dielectric disks is much higher where the ratio of the coupling coefficient to resonance width is low, but as that ratio gets higher once again we see that it agrees with the efficiency. This is why dielectric disks would be better suitable for operations where the coupling coefficient to resonance width is large which happens at closer distances rather than larger distances.

For the wire loops we see that there is a slight increase in absorption loss where the coupling coefficient to resonance width is small but the efficiencies do not change too much as the ratio gets better which is why values of 0.1 are accepted. This is why wire loops work better at larger distances.

One simulation that was run by MIT team to get a numerical idea on the efficiency is: Coupling at a distance of $D/r=5$, a “human” object at distance of $D/r = 10$ and a power of 10 watts transferred from source to device. The simulation for Dielectric Disks resulted in power losses of 4.4 watts radiating into free space, 0.3 watts dissipated inside the source, 0.2 watts dissipated inside the device, and 0.1 watts dissipated inside the human. These efficiencies are great for wireless transfer, 2/3 of the power actually got transferred from the source to the object. One of the minor problems is that 0.1 watts was transferred to humans. That isn’t a huge amount of power but if there are many devices

sending power in a small area it could lead to problems. The power losses inside wire loops were that, 1.5 watts radiated into free space, 11 watts was lost inside the source, 4 watts was lost inside the device, but note that 0 watts was lost to humans. This is why it is much safer alternative to use wire loops. We see that the efficiency here is much less than the Dielectric Disks but is still high for wireless power transfer [6].

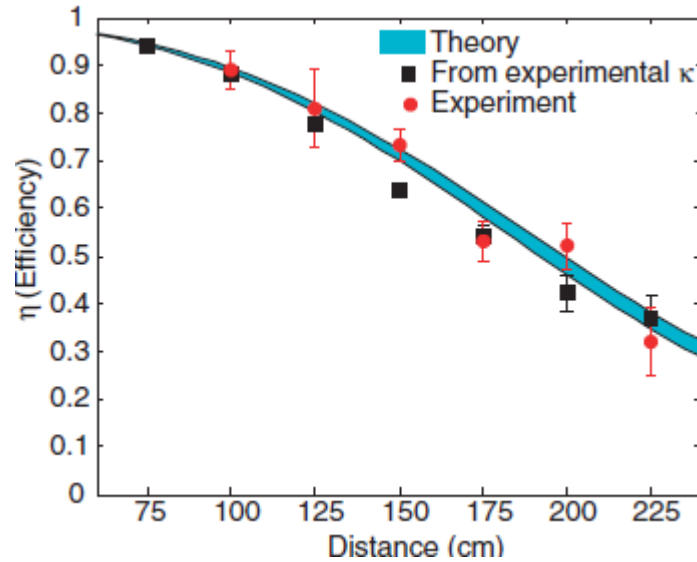

Fig.19: Comparison of experimental and theoretical efficiencies as functions of the wireless power distance [7]

As labeled on the Fig.14, the experimental power transfer efficiency of the coupled coils decayed with distance, as expected from the theory derived by the MIT team. At the highest tested coil separation of 225 cm, the efficiency was just below 40%. The paper, however, noted that the practical “wall-to-load” (ratio of power supplied by the wall outlet to the power received at the load) efficiency of the overall circuit was only 15%, which puts a lower bound on the theoretical efficiency of the system. Coil efficiency was further affected by a supposed “layer of poorly conducting copper oxide” on the wires forming the coil. While the measurements made between the coils agreed with the 40% theoretical value, the low overall efficiency was caused by the Colpitts oscillator. The researchers stated that the precise efficiency of the Colpitts oscillator is not known. The discrepancy between wall-to-load efficiency and wireless power transfer efficiency leaves room for improvement [7].

Kurs demonstrated that ordinary objects placed between the two resonating coils do not affect the magnetic field. Using foam, cardboard, and people as obstructions, the experimental efficiencies still remained relatively stable. In addition, the measured power radiation at the midway point between the two copper coils was roughly 5 W, an order of magnitude higher than that of cell phones. The authors noted that alternative resonance objects could be used in place of their specific coil design to reduce the power radiation to the levels specified by IEEE safety standards.

6. Applications

The technology of WiTricity finds its application in a wide range of consumer, commercial and industrial network. It facilitates efficient, safe, reliable and convenient means of power transfer.

6.1. WiTricity in Implantable Devices:

The advancement of medical science and biomedical technology provides therapeutic results in patients suffering from a variety of ailments. The various implantable devices used are implantable cardiac pacemakers, cardiac defibrillators, drug infusion pumps, deep brain stimulators, epilepsy monitors, cochlear implants, etc. A majority of these devices use a non-rechargeable battery which stores energy so as to operate for certain period of time. In order to supply constant power, the batteries need to be large in size. This makes the implantable devices expensive. In case of the cardiac pacemaker, the battery is placed along with the device and surgically implanted inside the body. Whenever the battery gets depleted, the entire device has to be surgically removed and replaced with a new battery and implanted back into the body. The entire procedure costs to the amount of \$25,000, making it the most expensive battery replacement in the world.

Many such implantable devices providing significant breakthrough in neurological disorders such as epilepsy, movement disorders, paralysis, memory failure, vision failure, etc. fail to reach the patients due to the economic constraints.

The infusion of WiTricity helps to bridge this economic gap by providing easy, reliable and cost effective methods of power supply. The implantable device can be recharged overnight using WiTricity source placed near the patient's body. In case of implants such as an artificial heart, the external recharging system can be kept anywhere near the patient rather than placing on the body of the patient. Another important medical feature is the sensory unit which provides information regarding important bodily parameters such as heart rate, glucose level, temperature, blood pressure, etc. Wireless body sensor units can be used for these purposes which are powered using a single source resonator on the principles of WiTricity. These units have made significant impact in the field of research and medical industry. Further advancement in this field has resulted in the development of thin film resonant cells having multiple conductor strips enabling them with multiple resonant frequencies. Thus using a single resonator, we can achieve simultaneous power transfer and communication using the different resonant frequencies. This greatly helps in reducing the size of the device and in the mean time improving its functionality and efficiency.

6.1.1. Structure of Energy Transmission System:

As mentioned earlier, WiTricity is based on the concept of strongly coupled magnetic resonance in the non-radiative near-field. The energy transmission system for implantable device based on WiTricity consists of a source, a driving circuit, two resonant coils, a rechargeable circuit and an implantable device, as shown in Fig. 20.[3]

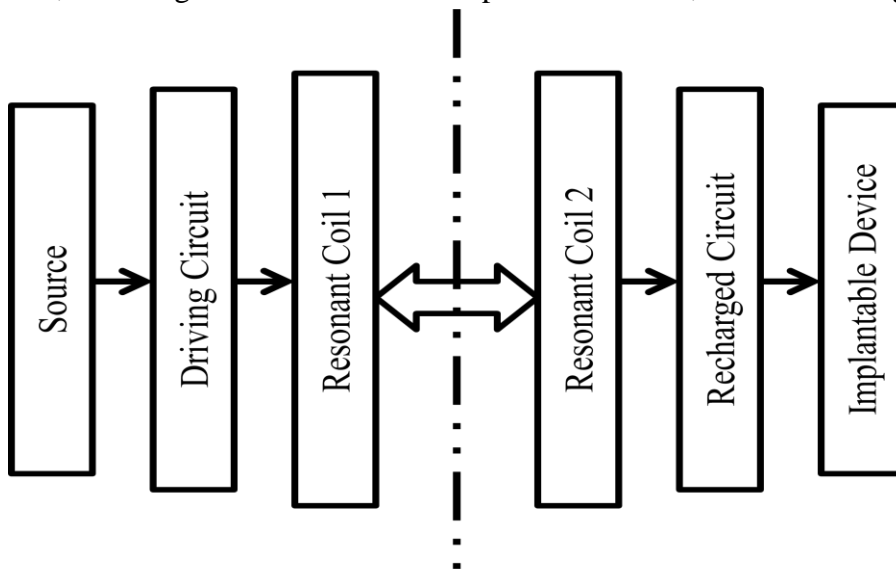

Fig.20: The scheme of energy transmission system for implantable device [3]

The above figure depicts how energy is transferred from the source to the implantable device. Both the resonant coils having the same resonant frequency are coupled inductively with their respective circuits. The driving circuit obtains energy from the source, whereas the recharged circuit provides power to the device. The energy transfer between the two coils, which are separated by a distance larger than the characteristic size of each coil, takes place through a strong coupling in their resonant field.

6.2. Solar Power:

WiTricity system can be implemented for wireless transmission of solar power to the interiors of homes and buildings. As shown in Fig.15, two thin film WiTricity resonators can be used; one behind the solar panel and the other inside of the building. The receiving cell in this case could be used as a source to power various devices with receiving coil inside the building.

A comparison between existing solar installations and wireless method is as shown below.

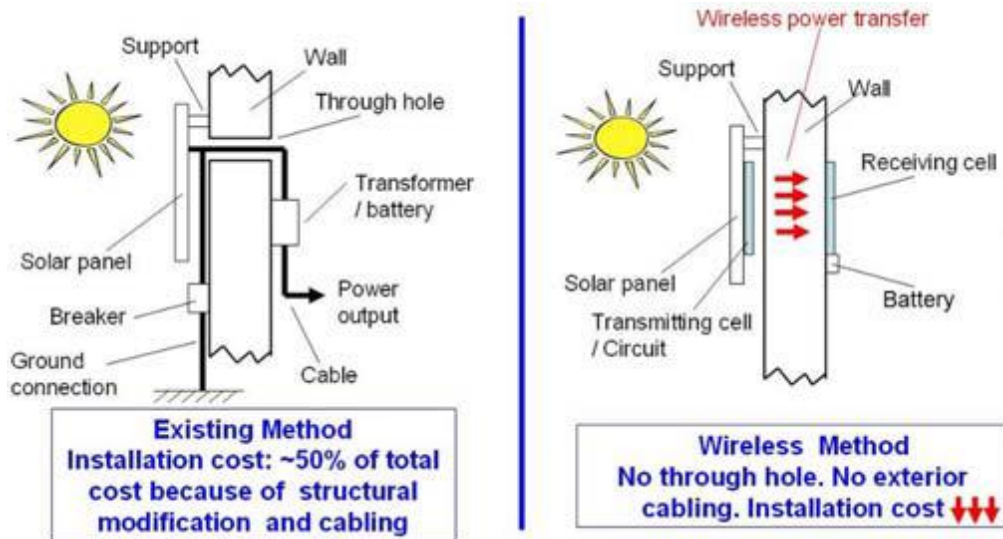

Fig.21: Comparison of existing and wireless solar panel systems [5]

Because of the wireless connection, most structural modifications to the house can be eliminated, installation costs can be reduced, and solar panels can be moved or replaced easily.

6.3. Consumer Electronics:

- ✓ Automatic wireless charging of mobile electronics (phones, laptops, game controllers, etc.) in home, car, office, Wi-Fi hotspots etc., while devices are in use and mobile.
- ✓ Direct wireless powering of desktop PC peripherals: wireless mouse, keyboard, printer, speakers, display, etc. Eliminating disposable batteries and awkward cabling.

6.4. Industrial:

- ✓ Direct wireless power and communication interconnections across rotating and moving “joints” (robots, packaging machinery, assembly machinery, machine tools). Eliminating costly and failure-prone wiring.
- ✓ Direct wireless power and communication interconnections at points of use in harsh environments (drilling, mining, underwater, etc.), where it is impractical or impossible to run wires.
- ✓ Direct wireless power for wireless sensors and actuators, eliminating the need for expensive power wiring or battery replacement and disposal.
- ✓ Automatic wireless charging for mobile robots, automatic guided vehicles, cordless tools and instruments. Eliminating complex docking mechanisms, and labour intensive manual recharging and battery replacement.

6.5. Other Applications:

- ✓ Direct wireless power interconnections and automatic wireless charging for Implantable medical devices (ventricular assist devices, pacemaker, etc.).
- ✓ Automatic wireless charging and for high tech military systems (battery powered mobile devices, covert sensors, unmanned mobile robots and aircraft, etc.).
- ✓ Direct wireless powering and automatic wireless charging of smart cards.
- ✓ Direct wireless powering and automatic wireless charging of consumer appliances, mobile robots, etc.

6.6. WiTricity technology will make products:

- ✓ More Convenient.
- ✓ No manual recharging or changing batteries.
- ✓ Eliminate unsightly, unwieldy and costly power cords.
- ✓ Never run out of battery power.
- ✓ Reduce product failure rates by fixing the 'weakest link': flexing wiring and mechanical interconnects.
- ✓ Reduce use of disposable batteries.
- ✓ Use efficient electric 'grid power' directly instead of inefficient battery charging.

7. Conclusion

As we have witnessed Witricity can effectively be used to transfer power wirelessly. Although with currently achieved efficiency, it is not practical to use WiTricity for all the electric devices, but it can be effectively used to recharge many of the mobile electronic devices with expensive batteries. WiTricity can be effectively used in implantable medical devices as it does not give rise to radio frequency emissions that interfere with other electronic devices, and is not a source of electric and magnetic field levels that pose a health hazard to people. WiTricity is a convenient and cost effective technology as it will help minimize the use of plastic and copper used in electric devices. This new technology has tremendous merits like high transmission integrity and low loss. As the resonant frequency gets tighter, the energy transferred to other objects drops away. With improved efficiency and range, this technology will change the way we look at energy transfer.

8. References

- [1] Fei Zhang, Steven A. Hackworth, Xiaoyu Liu, Haiyan Chen, Robert J. Scwabassi, and Mingui Sun, “Wireless Energy Transfer Platform for Medical Sensors and Implantable Devices”, 31st Annual International Conference of the IEEE EMBS, Minneapolis, Minnesota, USA, September 2-6, 2009.
- [2] Robert Puers, “Implantable Sensor Systems”.
- [3] Ning Yin, Guizhi Xu, Quingxin Yang, Jun Zhao, Xuewen Yang, Jianqiang Jin, Weinong Fu, and Mingui Sun, “Analysis of Wireless Energy Transmission for Implantable Device Based on Coupled Magnetic Resonance”, IEEE Transactions on Magnetics, vol.48, no.2, February 2012.
- [4] Fei Zhang, Steve A. Hackwoth, Xiaoyu Liu, Chengliu Li, and Mingui Sun, “Wireless Power Delivery for Wearable Sensors and Implants in Body Sensor Networks”, 32nd Annual International Conference of the IEEE EMBS, Buenos Aires, Argentina, August 31-September 4, 2010.
- [5] Steven A. Hackworth, Xiaoyu Liu, Chengliu Li, and Mingui Sun, “Wireless Solar Energy to Homes: A Magnetic Resonance Approach”, International Journal of Innovations in Energy Systems and Power, vol.5 no.1, April 2010.
- [6] Aristeidis Karalis*, J.D. Joannopoulos, and Marin Soljačić, “Efficient Wireless Non-radiative Mid-range Energy Transfer”.
- [7] A. Kurs, Aristeidis Karalis, Robert Moffatt, J. D. Joannopoulos, Peter Fisher, and Marin Soljacic, “Wireless Power Transfer via Strongly Coupled Magnetic Resonances”, Science, vol. 317 no. 5834, pp. 83-86, July 2007.
- [8] William A. Sahlam, and Evan Richardson, “WiTricity: Electricity cuts the cord”, Harvard Business School, N9-811-045, November 2010.
- [9] Hermann A. Haus, and Weiping Huang, “Coupled-Mode Theory”, Proceedings of the IEEE, vol. 79 no. 10, October 1991.
- [10] Biomedical Functional Imaging and Neuroengineering Laboratory, University of Minnesota.
- [11] J. Choi and C. Seo, “High-Efficiency Wireless Energy Transmission Using Magnetic Resonance Based On Metamaterial with Relative Permeability equal to -1”, Progress in Electromagnetics Research, vol. 106, 33-47, 2010
- [12] Wireless Power May Cut the Cord for Plug-In Devices, Including Cars
<http://news.nationalgeographic.com/news/energy/2012/12/121228-wireless-power/>, Date: 02/10/13

- [13] Wireless power transmission may cut the cord for electronic devices
<http://newsavalanche.com/2013/02/26/wireless-power-transmission-may-cut-the-cord-for-electric-devices/>, Date: 03/02/13
- [14] Wireless Electricity Delivered Over Distance
<http://www.witricity.com/pages/more.html>, Date: 01/29/13
- [15] Dragos Niculae, Lucia Dumitriu, Mihai Iordache, Andrei Ilie and Lucian Mandache, “Magnetic Resonant Coupling Used in Wireless Power Transfer to Charge the Electric Vehicle Batteries”, Agir Bulletin, October-December
- [16] www.witricity.com, Date: 02/27/13
- [17] Yueh-Ru Yang, “Steady-state Analysis and Simulation of a BJT Self-oscillating ZVS-CV Ballast Driven by a Saturable Transformer”, vol. 46 no. 2, 249-260, April 1999.
- [18] Giordano Seragnoli, “Self Oscillating Switching Power Supply with Output Voltage Regulated from the Primary Side”, U.S. patent number US RE37, 898 E, Reissued in November 2002.
- [19] Tu-Sheng Chen, Tsorng Juu Liang, Kai-Hui Chen and Jer-Nan Juang, “Study and Implementation of High Frequency Pulse LED Driver with Self Oscillating Circuit”, in Circuits and Systems (ISCAS), 2011 IEEE International Symposium on, pp. 498-501, May 15-18, 2011.
- [20] Wireless Power Efficiency
<http://www.wirelesspowerconsortium.com/technology/total-energy-consumption.html>,
Date: 03/21/13